

## Dynamic responses of train-track system to single rail irregularity

Jabbar Ali Zakeri<sup>1,\*</sup>, He Xia<sup>2</sup> and Jun Jie Fan<sup>2</sup>

<sup>1</sup>Assistant professor, School of Railway Engineering, Iran University of Science and Technology, Tehran, Narmak 16846-13114, Iran

<sup>2</sup> Professor, School of Civil Engineering & Architecture, Beijing Jiaotong University, Beijing 100084, China

### Abstract

A dynamic analysis method has been developed by which the vertical response of railway tracks subjected to a moving train can be investigated. The train and track are modeled as dynamic systems and the compound train-track system is treated as a whole. In the track model, the rail is treated as a Raleigh-Timoshenko beam and discretely supported, via rail pads, to flexible sleepers. The rail beam is modeled by using finite elements and two semi-infinite boundary elements at both ends. The wheel/rail contact is modeled by non-linear Hertzian spring elements. Based on this model, *DATI* computer software is designed to simulate the vertical dynamic interactions between railway tracks and vehicles. The model permits calculation of deflections, accelerations and forces in various track components, and also can study how parameters such as train speed, axle load, rail corrugations, wheel flats and so on influence the track and vehicle components.

**Keywords:** Dynamics of structures, track vibration, wheel/rail interaction and train/track interaction

## 1 Introduction

The technique of mathematically modeling the train and track has been extensively used to understand dynamic interactions between train and track. These dynamic interactions vary with operating conditions, type of train, type of track components, wheel and rail profiles, and climate conditions. It would be an impossible task to construct a single mathematical model that could be universally addressed to all aspects of train-track interactions. However, the complicated dynamic behavior that results from these interactions can be studied by using various mathematical models, each of which concentrates on a specific area of interest.

Presently, the standard track is continuously welded rail laid on concrete sleepers with an intervening rail pad. The rail pads protect the sleepers from wear and provide electrical insulation. They also affect the dynamic behavior of the whole track, as the stiffness and damping of the track are influenced by the properties of the rail pads.

---

\*Corresp. author email: zakeri@iust.ac.ir

In the frequency range of interest it is assumed that the flexibility of the sleepers will permit the two rails to vibrate independently, so that only one need be considered.

Several track models have been developed during last thirty years. They vary in complexity from an infinite, uniform, *Euler-Bernoulli* beam supported by a continuous viscoelastic *Winkler* foundation, to complex models with several degrees of freedom.

The simplest model, (an infinite beam on an elastic foundation) was used by *Timoshenko* [9] to calculate the deflection of the rail under both static and dynamic loads. In some of the previous papers [16], the analysis of periodic systems was generally limited to establishing the characteristics of free wave propagation and the natural modes. The discrete nature of the rail support components has been developed in track modeling by a number of authors such as Grassie [4], Clark [3], Ishida [11], Cai [2], Nielsen [8], Xia [15] and Zakeri [17–19].

Knothe and Grassie [7] have given an overview of railway track models. Both frequency domain models and time domain models are used in the literature. Time domain models are often studied by use of modal analysis methods. Other treatment of railway track dynamics has been published in references [1, 6].

In this paper, a special model of train/track interaction is established by using the finite element method and two infinite boundary elements at both ends of selected track. Based on this model, *DATI* computer software is designed. The program name is an acronym for a **D**ynamic **A**nalysis of **T**rain - **T**rack **I**nteraction. In section 7, *DATI* software has been applied to calculate the time histories of displacement, velocities, accelerations of the whole system and dynamic forces between wheels and rails.

## 2 Vehicle Model and Equations

Generally, in constructing a mathematical model for studying the dynamic behavior of vehicles, the components of the system are assumed to be rigid bodies. A rigid body has six dynamic degrees of freedom, which correspond to the three displacements (longitudinal, lateral and vertical) and three rotations (pitching, rolling and yawing). Because each dynamic degree of freedom results in a second order coupled differential equation,  $6N$  differential equations will be required to represent the system mathematically, in which  $N$  denotes the number of components in the system. Solutions for all of these differential equations are unnecessary. Therefore, it is important to establish the objective of a mathematical model.

It has been observed that a relatively weak coupling exists between the vertical and lateral motions of a vehicle and, therefore, that may not be necessary to include the lateral degrees of freedom in the study of the vertical response.

The schematic of the general four-axle vehicle is shown in Figure (1). The model consists of a car-body, two bogies (truck frames), and four wheel-axle sets.

In the present study, only vibrations in the vertical plane are studied. It is assumed that the loading is symmetrically distributed on the two rails. Thus a model of half the vehicle is

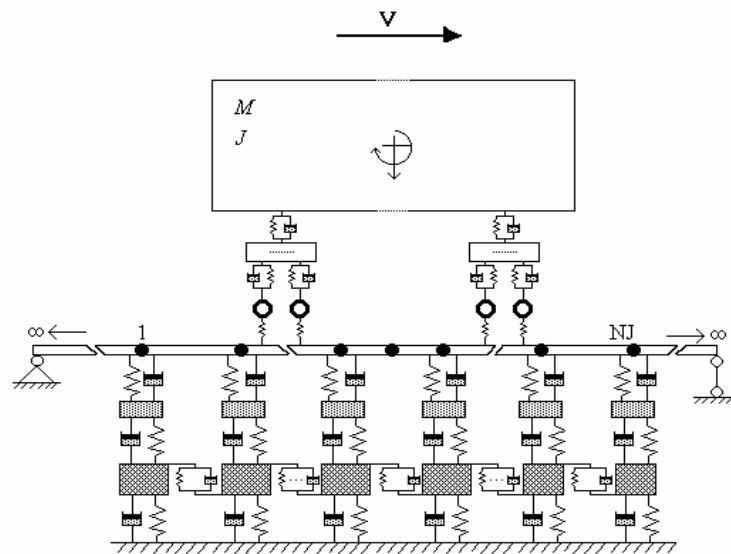

Figure 1: Train - track interaction model

sufficient ([15]).

According to the above mentioned descriptions, the following hypotheses are made for the vehicle model:

- a- car bodies, bogie frames and wheelsets are considered to be rigid, neglecting their elastic deformation in vibration;
- b- all of the dampers are of viscous damping;
- c- Only vertical movements (heaving and pitching) of vehicle components are considered.

The track/train interaction system is illustrated in Figure (1). The vehicle is modeled with ten degrees of freedom including the vehicle body mass and its moment of inertia, the two bogie masses and their moments of inertia, and four wheelsets unsprung masses. The bogie frame mass is connected to the wheel unsprung mass through the primary suspension springs and connected to the vehicle body mass through the secondary suspension springs.

For vehicle body, the equations governing the vertical deflection and pitching motions of the lumped masses can be entirely described using second order ordinary differential equations in the time domain. They are formulated by applying the D'Alembert principle. The equations for the  $i$ th Vehicle can be expressed in terms of the standard matrix form (Appendix 2).

### 3 Track Model and Equations

A linear finite element model of the railway track accounting for discrete sleeper supports has been developed. The track subsystem is illustrated in Figure (1). The vertical track model considers a conventional ballasted sleeper track. In this model, the rail is described by the Timoshenko beam theory. It is assumed that the rail beam is periodically coupled at discrete points to the cross-track sleeper beams through the coupling spring/damper elements representing the resilience and damping of the rail pads and rail fastening mechanisms [13].

For an analytical study, these track components need to be physically idealized to establish a representative model within the reach of mathematical solutions.

#### 3.1 Rail Model and Equations

For dynamic analysis of the track, which was undertaken before about 1960, the rail was considered to be a Bernoulli-beam (in frequency domain). In this paper, a finite length of track is selected and the rail is considered as a Timoshenko beam. This continuous beam can be divided into finite segments. In the both ends of rail, semi-infinite boundary elements are introduced.

The fundamental characteristic of the track structure is its periodic, or chain-type structural construction composed of two parallel rails and equally spaced sleepers. In the present research work, the stiffness, damping and mass matrices of track elements are calculated by using the direct stiffness method. It seems impossible to include a physically infinite track directly in a finite element model if a time step integration technique is used to calculate the train/track interactions. A limitation with this method is that only finite lengths of track can be used in the simulation.

The general equations of motion for a multiple-degree of freedom discrete system with  $N$  degrees of freedom are written as

$$[M] \{\ddot{z}\} + [C] \{\dot{z}\} + [K] \{z\} = \{F(t)\} \quad (1)$$

Where  $\{F(t)\}$  denotes the externally applied forces,  $[M]$ ,  $[C]$  and  $[K]$  are mass, damping and stiffness matrices, respectively. In the following sections these three matrices are described in details.

##### 3.1.1 Stiffness Matrix of Rail Structure

The rail is assumed as a uniform beam segment with cross-sectional moment of inertia  $I$ , length  $L$ , shear area  $A_y$ , material modulus of elasticity  $E$ ,  $NJ$  nodes and  $NE$  elements. Each node of the beam (rail structure) has two degrees of freedom. In structural mechanics, the relation between static forces and moments and the corresponding linear and angular displacements at the ends of the beam segment has been established. This relation is the stiffness matrix for a beam segment. The next objective is to obtain the system stiffness matrix from the stiffness

matrix of each element of the system.

The rail beam in Figure (4) has been divided into  $NE$  elements. Though, there are  $NJ$  nodes in the rail beam with a total of  $2 \times NJ$  nodal coordinates. The system stiffness matrix can be obtained by assembling the stiffness matrices of elements. Because of the chain-type structure of the rail beam, the system stiffness matrix is a banded matrix.

### 3.1.2 Mass Matrix of Rail Structure

The consistent mass method is used for considering the inertial properties. In this method, the mass coefficients corresponding to the nodal coordinates of a beam element can be evaluated by a procedure similar to determination of element stiffness coefficients.

### 3.1.3 Damping Matrix of Rail Structure

For the rail structure, the damping matrix is formed by assumption of Rayleigh damping, it means:

$$[C] = \alpha [M] + \beta [K] \quad (2)$$

The damping ratio for the  $n$ th mode of the system is:

$$\zeta_n = \frac{\alpha}{2} \frac{1}{\omega_n} + \frac{\beta}{2} \omega_n \quad (3)$$

Coefficients  $\alpha$  and  $\beta$  can be determined from specified damping ratios  $\zeta_i$  and  $\zeta_j$  for the  $i$ th and  $j$ th modes, respectively. Expressing equation (3) for these two modes in matrix form leads to:

$$\frac{1}{2} \begin{bmatrix} 1/\omega_i & \omega_i \\ 1/\omega_j & \omega_j \end{bmatrix} \begin{Bmatrix} \alpha \\ \beta \end{Bmatrix} = \begin{Bmatrix} \zeta_i \\ \zeta_j \end{Bmatrix} \quad (4)$$

These two algebraic equations can be solved to determine the coefficients  $\alpha$  and  $\beta$ . [17]

## 3.2 Rail Fastening System Model

The fastening system commonly used on concrete sleepers comprises a resilient spring fastening, many design of which are available, acting essentially in parallel with a much stiffer railpad. Typically the railpad is made of rubber, plastic or composite materials such as rubber-bonded cork. The load-deflection behavior of the fastening system is non-linear, but since its behavior when a loaded wheel is near the sleeper is of greatest interest some linearization of the load-deflection behavior is justified.

For vertical vibration a pad is usually modeled as a spring and viscous dashpot in parallel. A model of the pad damping as structural with a constant loss factor has also been used and is actually more consistent with the known behavior of materials such as rubber. For rail and track

models, which are essentially three dimensional it is convenient to represent the pad as a visco-elastic layer, distributed across the railfoot. In two-dimensional models it can be represented as acting at a point on the rail foot.

### 3.3 Sleeper Model and Equations

The most complete sleeper model is a Timoshenko beam of variable thickness, which can readily be analyzed by using finite elements. In this study, half of the sleeper is modeled by use of three uniform beam elements on visco –elastic foundation, as shown in Figure (2).

The stiffness matrix of the element on visco-elastic foundation is obtained by adding the stiffness matrices  $K_{ij}$  and  $K_{FF}$  pertaining to the usual beam bending and foundation modulus, respectively (Thambiratnam [12]). The distributed spring /dashpot constants beneath each sleeper represent the elasticity and damping effect of the track foundation. To account for uneven ballast/subgrade compaction efforts across the track, the distributed stiffness/damping coefficient beneath the center portion of the sleeper may be assumed to be different from (always lower than) that beneath the two end segments of sleeper.

$$k_{FF} = \begin{bmatrix} \frac{13kl}{35} & & & & SYM. \\ \frac{11kl^2}{210} & \frac{kl^3}{105} & & & \\ \frac{9kl}{70} & \frac{13kl^2}{420} & \frac{13kl}{35} & & \\ -\frac{13kl^2}{420} & -\frac{kl^3}{140} & -\frac{11kl^2}{210} & \frac{kl^3}{105} & \end{bmatrix} \quad (5)$$

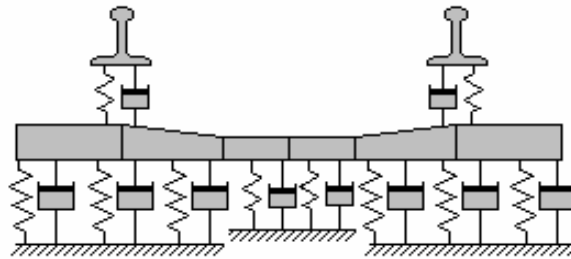

Figure 2: Sleeper beam on visco-elastic foundation

When the stiffness matrix of any beam is derived, the “put it in the right seat” rule can be used to assemble the stiffness matrix of the sleeper. Calculation of the damping matrix of the sleeper has the same procedure. For the second node of the sleeper, the following equations can be established:

$$M_{si}\ddot{Z}_{si} + K_{pi}(Z_{si}(t) - Z_r(x,t)) + K_{bi}(Z_{si}(t) - Z_{bi}(t)) + C_{pi}(\dot{z}_{si}(t) - \dot{Z}_r(x,t)) + C_{bi}(\dot{Z}_{si}(t) - \dot{Z}_{bi}(t)) = 0 \tag{6}$$

### 3.4 Ballast Model and Equations

A sufficient sleeper support model, which has been used by Sato [10] and Zhai [14], is shown in Figure (1). This model includes additional ballast masses below each sleeper, which are interconnected by spring and dashpots in shear. The attraction of such a model is that it offers the possibility of obtaining better correlation between calculated and measured responses. In practice the insensitivity of the response to the five additional parameters (stiffness and damping values for the shear connection and for the substrate, plus the additional ballast mass) may make it difficult to obtain satisfactory parameter values from experimental data. Zhai [14] has accordingly tried to estimate the five parameters theoretically. Some of observations suggest that it may be desirable to introduce an independent ballast mass. In this paper, we also consider independent ballast mass with interlocking between ballast particles.

For the ballast block, the equations governing the vertical deflection of the lumped masses can be entirely described using second order ordinary differential equations in the time domain. They are formulated by applying the D’Alembert principle and are given below:

$$M_{bi}\ddot{Z}_{bi}(t) + K_{bi}(Z_{bi}(t) - Z_{si}(t)) + K_{fi}Z_{bi}(t) + K_{sh}(2Z_{bi}(t) - Z_{b(i+1)}(t) - Z_{b(i-1)}(t)) + C_{bi}(\dot{Z}_{bi}(t) - \dot{Z}_{si}(t)) + C_{fi}\dot{Z}_{bi}(t) + C_{sh}(2\dot{Z}_{bi}(t) - \dot{Z}_{b(i+1)}(t) - \dot{Z}_{b(i-1)}(t)) = 0 \tag{7}$$

### 4 Wheel-Rail Contact Model

The last component, which is necessary to model in the dynamic system of train and track, is the wheel-rail contact. Elkins [5] has recently surveyed work in this area. For the normal contact problem the assumption of Hertzian contact theory are valid in the most circumstances, so that a nonlinear or linearized contact spring can be introduced (Figure 3).

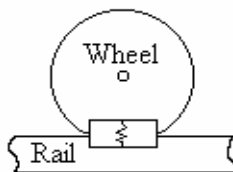

Figure 3: Vertical contact modelling-nonlinear Hertzian spring

In this study, the wheel-rail contact is modeled by a non-linear Hertzian spring in which a two third power law relates the force and deflection (unless loss of contact occurs).

$$f_j(t) = C_H [\delta Z_j(t)]^{\frac{3}{2}} \quad (8)$$

$$\delta Z_j(t) = Z_{wj}(t) - Z_r(x_j, t) - R(x_j, t)$$

$$f_j(t) = 0 \text{ IF } Z_{wj}(t) \leq Z_r(x_j, t) + R(x_j, t)$$

Where  $f_j(t)$  = wheel-rail contact force,  $Z_{wj}(t)$  = wheel displacement,  $Z_r(x_j, t)$  is the vertical deflection of rail underneath of  $j$ th wheel,  $C_H$  = Hertzian contact coefficient,  $R(x_j, t)$  is the surface irregularities of rail or track underneath the  $j$ th wheel. Because of simplicity and using numerical time-step integration for solving the interaction problem, non-linear Hertzian contact stiffness can be linearized by  $k_{Hj} = C_H [Z_{wj} - Z_r(x_j, t) - R(x_j, t)]^{\frac{1}{2}}$  If

$$Z_{wj}(t) \geq Z_r(x_j, t) + R(x_j, t)$$

$$k_{Hj} = 0 \text{ If } Z_{wj}(t) \leq Z_r(x_j, t) + R(x_j, t) \quad (9)$$

The stiffness matrix of the whole system depends on the Hertzian contact stiffness  $k_{Hj}$ . For solving the equations of the whole system with non-linear Hertzian theory, it is better to use iteration method for calculating  $k_{Hj}$  in each time step.

During calculation, if the wheel loses its contact point with rail, the Hertzian contact stiffness will be zero.

## 5 Equations of the Whole System

The number of nodes in rail structure is  $NJ$  and the number of sleepers in selected length of track is  $NS$ . Therefore, the dimension of the above-mentioned matrices is equal to  $10 + 2NJ + 5NS$ . By properly assembling the matrices of rail elements and the matrices of discrete support components, the track dynamic equations may be expressed as:

$$M \{\ddot{z}\} + C \{\dot{z}\} + K \{z\} = \{F\} \quad (10)$$

In which  $M$ ,  $C$  and  $K$  are generalized mass, damping and stiffness matrices of the track. By using partition matrices, the above mentioned matrices of the whole system (train + track) can be written as:

Where: C/W is the sub-matrix for bogies-wheel interaction coefficients; R/W is the sub-matrix for rail-wheel interaction coefficients; R/S is the sub-matrix for rail-sleepers interaction coefficients and S/B is the sub-matrix for sleepers-ballast interaction coefficients.



Carbody & Bogie	C/W	0	0	0
C/W	Wheel	W/R	0	0
0	W/R	Rail	R/S	0
0	0	R/S	Sleeper	S/B
0	0	0	S/B	Ballast

### 6 Solution Method

The general equations of motion for a multiple-degree of freedom discrete system with  $N$  degrees of freedom are written as Eqn. (10).

In order to solve the second order differential equation (10) with high degrees of freedom involving nonlinearity, due to the nonlinear contact forces between wheels and rails, the direct time integration method must be adopted to obtain numerical results in the time domain.

In this paper, Newmark method has adopted for solving differential equation (10). Newmark developed a family of time stepping methods based on the following equations:

$$\begin{aligned} \dot{z}_{i+1} &= \dot{z}_i + [(1 - \gamma) \Delta t] \ddot{z}_i + (\gamma \Delta t) \ddot{z}_{i+1} \\ z_{i+1} &= z_i + (\Delta t) \dot{z}_i + \left[ (0.5 - \beta) (\Delta t)^2 \right] \ddot{z}_i + \left[ \beta (\Delta t)^2 \right] \ddot{z}_{i+1} \end{aligned} \tag{11}$$

*DATI* computer software is designed to simulate the vertical dynamic interactions between railway tracks and vehicles. The time histories of displacement, velocities, accelerations of the whole system and dynamic forces between wheels and rails can be completely calculated.

The calculated results are well in accordance, both in response curves, in amplitudes and in distribution tendencies, with the existing experimental data [19], which verified the effectiveness of the analytical model and the computer simulation method.

Since the interaction problem is generally solved by use of numerical time-integration, the computer time when employing this type of track model substantially exceeds the time required in an analysis of less detailed models.

In a personal computer a primary limitation is the available memory, and it is not possible to retain all of the necessary arrays in core at one time. Accordingly, an out-of-core frontal system is adopted to solve linear algebraic equations. A simple memory management system utilizing the main memory and disk files is used to store large arrays resulting from the global coefficient matrix and any element history terms. For implementation on larger computers with virtual memory management, it is more efficient to avoid using disk files as much as possible. Accordingly, for these systems an in-core variable band solver is included as an equation-solving option. In this program, the banded matrices have been used.

## 7 Application of *DATI* program

The track and rail imperfections which may be investigated by this program are: rail corrugation, track irregularities, single imperfections such as bad welded joint, existence of unsupported sleeper, existence of rail joint, damaged fastening, existence of primary clearance in sleeper support. The following items are used in this program:

- (1) The effects of shear and rotational inertia is considered in the rail model by using Timoshenko beam theory;
- (2) Non-linear contact behavior for wheel-Rail interface (loss of contact) is used;
- (3) The sleeper is modeled as a non-uniform Timoshenko beam on visco-elastic foundation by using finite elements model;
- (4) For these systems an in-core variable band solver is included as an equation-solving option;
- (5) Symmetric loading of track;
- (6) New boundary conditions are introduced by using two infinite boundary elements;
- (7) Considering track imperfections such as the above mentioned cases;
- (8) Accounting the shearing continuity of the interlocking ballast particles.

### 7.1 Steady- State Responses of the System

Before studying the dynamic responses of the vehicle-track system for rail irregularities, a vehicle traveling at a constant speed over a track with no irregularities is considered in order to study its steady-state responses.

Here, UIC60 rail and ICE2 train are used, for which all of the technical parameters are shown in Tab.1 (adopted from [18]).

A length of 53 sleeper-spacing is used in this example. According to Figure (4), there are 59 joints, 52 rail supports and 58 rail elements. Displacements, accelerations and velocities of the joint No 30 (mid joint of selected track) and that of joint No 28 (mid support of rail track) are calculated. Also wheel-rail vertical force of first and second wheels and rail / sleeper forces are calculated. The train speed is considered as 160 km/h.

Table 2 shows the maximum responses of track components. The steady-state wheel/rail force response is shown in Figure (5). This figure shows that the response of the system is periodic and the dominant wavelength is equal to the sleeper spacing. The point where the peak force occurs depends on train speed and sleeper spacing. For this condition, the peak force occurs in over the sleepers. In the following results, displacements, velocity and accelerations are expressed in terms of mm, cm/s and gravity acceleration, respectively.

Table 1: Track and vehicle parameters

Track Model Parameters	Vehicle Model Parameters
$E = 206 \times 10^6 \text{ kN/m}$	$M_C = 49500 \text{ kg}$
$I = 32.2 \times 10^{-6} \text{ m}^4$	$J_C = 1.7 \times 10^3 \text{ T.m}^2$
$M_r = 60 \text{ kg/m}$	$L_C = 19.0 \text{ m}$
$K_P = 240 \times 10^3 \text{ kN/m}$	$M_t = 10750.0 \text{ kg}$
$C_P = 248.0 \text{ kN.S/m}$	$J_t = 9.60 \text{ T.m}^2$
$M_S = 320 \text{ kg}$	$L_t = 2.5 \text{ m}$
$K_B = 70 \times 10^3 \text{ kN/m}$	$K_T = 1720.0 \text{ kN/m}$
$C_B = 180.0 \text{ kN.S/m}$	$C_r = 300.0 \text{ kN.S/m}$
$M_B = 1400.0 \text{ kg}$	$M_W = 2200.0 \text{ kg}$
$K_F = 130 \times 10^3 \text{ kN/m}$	$K_w = 4360.0 \text{ kN/m}$
$C_F = 62.3 \text{ kN.S/m}$	$C_w = 220.0 \text{ kN.S/m}$
$L = 29.15 \text{ m}$	$K_H = 2.4 \times 10^5 \text{ kN/m}$

Table 2: Maximum Vibration Responses of Track Components

Responses	Rail (mid-span)	Rail (support)	Sleeper	Ballast
Displacement (mm)	1.693	1.649	1.415	0.531
Acceleration (g)	8.2	4.24	2.26	1.05
Velocity (cm/s)	7.61	7.24	6.59	3.1

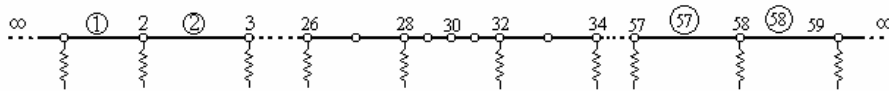

Figure 4: Rail structure of track

The force fluctuates at sleeper passing frequency but the amplitude of these fluctuations is less than 112% of the static wheel load at 160 km/h. Such a variation is of no significance in giving rise to corrugation on the rail head.

Figures (6 & 7) show the responses of the track components under passing of the vehicle (Time History Diagrams). In these figures, the responses of the track in joints 28 (rail in support) and 30 (mid-span of rail) are calculated. Static load is equal to 97.85 kN.

### 7.2 Dynamic Responses of the System to Single Irregularity

Single irregularity of rail such as bad welded joints and settlement of ballast is another source of excitation in train/track interactions. In this section, responses of track structures under single irregularity of rail are treated. It is necessary to mention that the computer program, *DATI*,

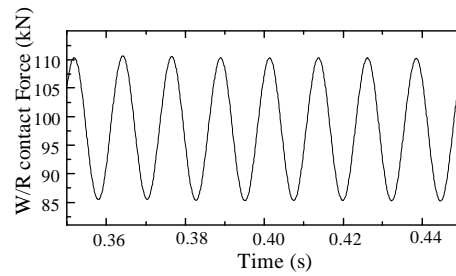

Figure 5: Steady-state W/R force response

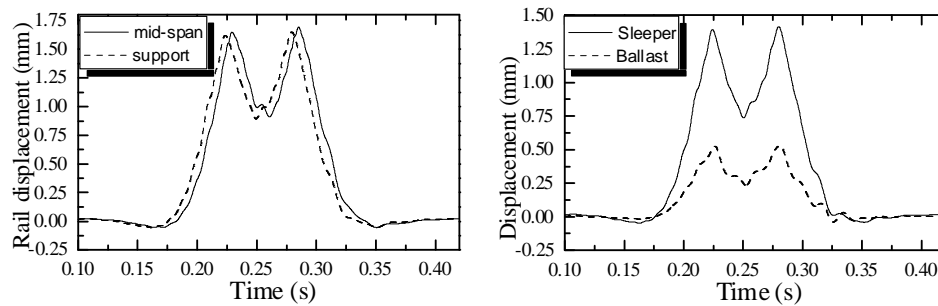

Figure 6: Rail, sleeper and ballast displacement under passing of a bogie

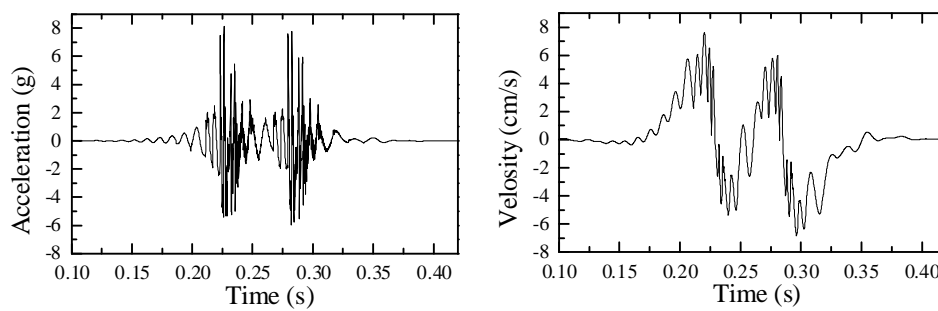

Figure 7: Acceleration and velocity of rail at mid-point

has capability of using all types of single irregularities. For instance, the V shape irregularity in Figure (8) is used as input for *DATI* and the following results has obtained.

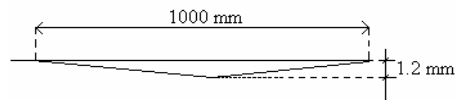

Figure 8: The V-shape irregularity

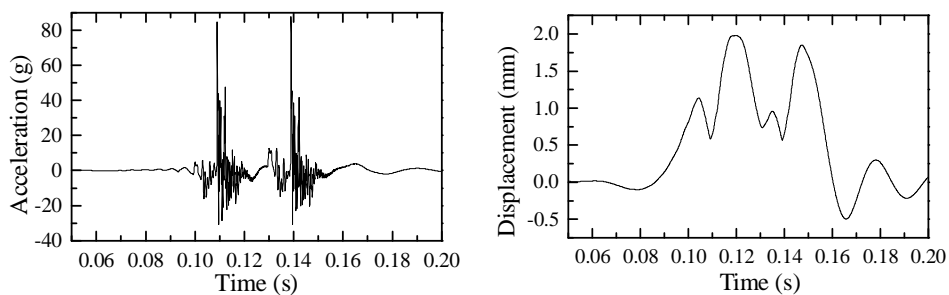

Figure 9: Time History of rail acceleration and displacement during passing a bogie

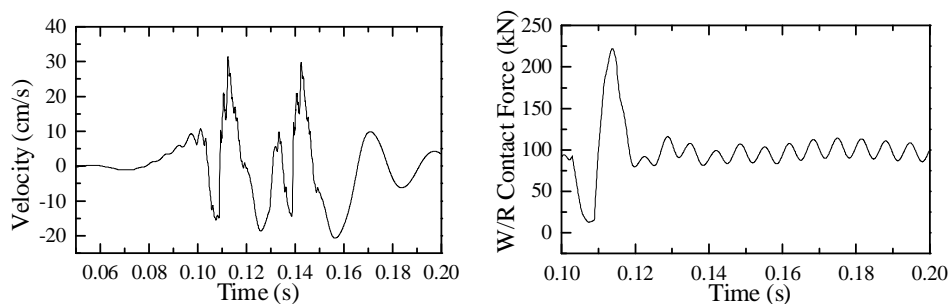

Figure 10: Time History of rail velocity and W/R contact forces during passing a bogie

The figures (9 - 11) are comparable with the figures (5 - 7) in smooth rail and the following results have been obtained.

- Maximum displacement, acceleration and velocity of rail increase 117%, 987% and 414%, respectively.
- Maximum wheel/rail contact force, rail/sleeper and sleeper/ballast interactive forces increase 198%, 243% and 210%, respectively.

Study on the dynamic responses of the vehicle-track system for periodic irregularities based on this model, has been presented in the last papers of authors.

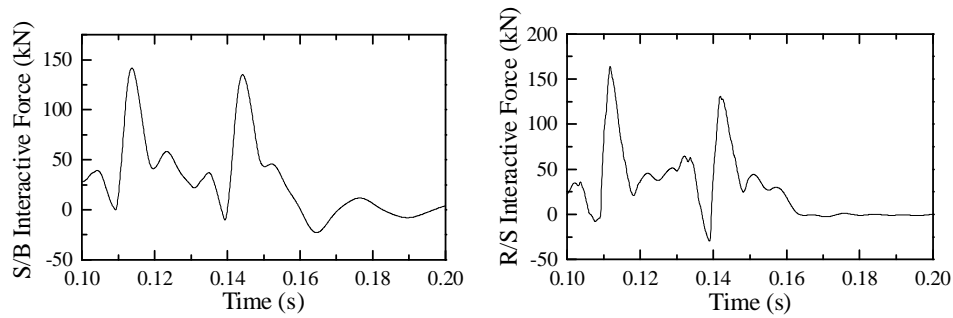

Figure 11: Time History of R/S and S/B interactive forces during passing a bogie

## 8 Conclusions

- (1) The spatial model has been developed for the simulation of dynamic train-track interactions by using finite and infinite elements.
- (2) The general equations of motion of track and train components are deduced.
- (3) The application of this model and results of the calculation are presented. Steady-state responses and dynamic responses of the track to rail corrugation excitations are discussed.
- (4) Based on this model, computer software *DATI* is designed to simulate the vertical dynamic interactions between railway tracks and vehicles.
- (5) This model permits calculation of deflections, accelerations and forces in various track components, and also can investigate how parameters such as train speed, axle load, rail corrugations, wheel flats and so on influence the track and vehicle components.
- (6) The application of this model and results of the calculation are presented. Steady-state responses of the track are discussed.
- (7) Because of single irregularity, all of the track responses increase. Capabilities of *DATI* in using all kind of irregularities are shown.
- (8) All of the above mentioned forces and accelerations are quantified.

## References

- [1] Y. B. Yang, J. D. Yau, and Y. S. Wu. *Vehicle - Bridge Interaction Dynamics*. World Scientific Publication, 2004.
- [2] Z. Cai and G. Raymond. Use of a generalized beam/spring element to analyze natural vibration of rail track and its application. *J. Mech. Eng. Sci.*, 36(9):863–876, 1994.

- 
- [3] R. Clark, P. Dean, J. Elkins, and S. Newton. An investigation into the dynamic effects of railway vehicles running on corrugated rails. *J. Mech. Eng. Sci.*, 24(2):65–76, 1982.
- [4] S. Grassie, R. Gregory, D. Harrison, and K. Johnson. The dynamic response of railway track to high frequency vertical excitation. *J. Mech. Eng. Sci.*, 24(2):77–90, 1982.
- [5] *Prediction of wheel/rail interaction: the state of the art.*, Lyon, France, 1991. Proceedings of the 12th IAVSD Symposium on the Dynamics of Vehicles on Roads and on Tracks. 1-27.
- [6] H. Jenkins, J. E. Stephenson, G. A. Clayton, G. W. Morland, and D. Lyon. The effect of track and vehicle parameters on wheel-rail vertical dynamic forces. *Railway Eng. J.*, 3:2–16, 1974.
- [7] K. Knothe and S. Grassie. Modelling of railway track and vehicle/track interaction at high frequencies. *Veh. Sys. Dyn.*, 22:209–262, 1993.
- [8] J. Nielsen and A. Igeland. Vertical dynamic interaction between train and track influence of wheel and track imperfections. *J. Sound Vib.*, 187(5):825–839, 1995.
- [9] *Method of analysis of statical and dynamical stress in rails.*, Zurich, 1926. 2nd Int. Congress of Applied Mechanics. 407-418.
- [10] Y. Sato. Study on high frequency vibrations in track operated with high speed trains. *JNR Qua. Rep.*, 18(3):109–114, 1977.
- [11] T. Susuki and M. Ishida. Measurement on dynamic behavior of track near joints and prediction of track settlement. *QR of RTRI*, 46(2), 2006.
- [12] D. Thambiratnam and Y. Zhuge. Dynamic analysis of beams on elastic foundation subjected to moving loads. *J. S. Vib.*, 198(2):149–169, 1996.
- [13] A.V. Vostroukhov and A.V. Metrikine. Periodically supported beam on a visco-elastic layer as a model for dynamic analysis of a high-speed railway track. *International Journal of Solids and Structures*, 40:5723–5752, 2003.
- [14] *A detailed model for investigating interaction between railway vehicle and track.*, Chengdu, China, 1993. Proceedings of the 13th IAVSD Symposium on the Dynamics of Vehicles on Roads and on Tracks. 603-615.
- [15] H. Xia, M. Zhang, N. Wei, and J. Wen. Study of vibration effects of underground trains on surrounding environments. In Xia H. and Chen Y., editors, *Advances in Structural Engineering*, pages 116–122. China Railway Publishing house, 1995.
- [16] A. Yoshimura and M. Miwa. *Study on vertical dynamic vehicle-track interactions using the TRADYS test facility and computer simulation*. 88. WIT Press, 2006. WIT Transactions on The Built Environment.
- [17] J. A. Zakeri. *Computer simulation for dynamics of railway track structures*. Ph.d. thesis, Beijing Jiaotong University, Beijing, 2000.
- [18] J. A. Zakeri and H. Xia. Sensitivity analysis of track parameters on train-track dynamic interaction. *Journal of Mechanical science and Technology*, 22(7):1299–1304, 2008.
- [19] J. A. Zakeri, H. Xia, and J. J. Fan. Effects of unsupported sleeper on dynamic responses of railway track. *Journal of Northern Jiaotong University*, 24(1):50–55, 2000.

## Appendix 1

The following nomenclatures are used in the paper (in alphabetical order):

$C_{bi}$	Ballast damping in the $i$ th support	$l_t$	Half of distance between centers of wheel-axes in one bogie
$C_{fi}$	Formation (sub-Ballast) damping in the $i$ th support	$M_b$	Ballast mass
$C_p$	Railpad damping	$M_c$	Car body mass
$C_{sh}$	Ballast shear damping	$M_R$	Rail mass (per unit length)
$C_t$	Vertical secondary damping		
$C_w$	Vertical primary damping	$M_t$	Bogie mass
$J_c$	Nodding moment of inertia- car body	$M_w$	Wheel-set mass
$J_{tj}$	Nodding moment of inertia- $j$ th bogie	$R_s(x_{ij})$	Surface irregularities of rail
$K_{bi}$	Ballast stiffness in the $i$ th support	$Z_{bi}$	Ballast vertical displacement
$K_f$	Formation stiffness in the $i$ th support	$Z_c$	Car-body vertical displacement
$K_H$	Linearized Hertzian stiffness	$Z_r(x, t)$	Rail vertical displacement in the $x$ coordinates
$K_p$	Railpad stiffness	$Z_{si}$	Sleeper vertical displacement
$K_{sh}$	Ballast shear stiffness	$Z_{tj}$	Vertical displacement of $j$ th bogie
$K_t$	Secondary vertical stiffness	$Z_{wj}$	Vertical displacement of $j$ th wheel
$K_w$	Primary vertical stiffness	$\psi_c$	Car body nodding angle
$l_c$	Half of distance between bogie centers	$\psi_{ti}$	The $i$ th bogie nodding angle

## Appendix 2

The mass, damping and stiffness matrices of vehicle can be expressed as follows: (nomenclatures in Appendix 1)

$$\text{Diag } M_i = [M_c, J_c, M_{t1}, J_{t1}, M_{t2}, J_{t2}, M_{w1}, M_{w2}, M_{w3}, M_{w4}]$$

$F_i$ , the load vector is:

$$F_i^T = [0 \ 0 \ 0 \ 0 \ 0 \ 0 \ -f_{w1}(t) \ -f_{w2}(t) \ -f_{w3}(t) \ -f_{w4}(t)]$$

$$f_{wj} = K_H [Z_{wj} - Z_r(x_{ij}, t) - R_s(x_{ij})]^{\frac{3}{2}}$$

$R_s(x_{ij})$  = Surface irregularities of rail or track underneath of  $j$ th wheel of the  $i$ th vehicle.

$K_i$ , the stiffness matrix of the vehicle, is equal to:

$$\begin{bmatrix} 2k_t & 0 & -k_t & 0 & -k_t & 0 & 0 & 0 & 0 & 0 \\ 0 & 2k_t l_c^2 & -k_t l_c & 0 & -k_t l_c & 0 & 0 & 0 & 0 & 0 \\ -k_t & -k_t l_c & k_t + 2k_w & 0 & 0 & 0 & -k_w & -k_w & 0 & 0 \\ 0 & 0 & 0 & 2k_w l_t^2 & 0 & 0 & -k_w l_t & -k_w l_t & 0 & 0 \\ -k_t & -k_t l_c & 0 & 0 & k_t + 2k_w & 0 & 0 & 0 & -k_w & -k_w \\ 0 & 0 & 0 & 0 & 0 & 2k_w l_t^2 & 0 & 0 & -k_w l_t & -k_w l_t \\ 0 & 0 & -k_w & -k_w l_t & 0 & 0 & k_w & 0 & 0 & 0 \\ 0 & 0 & -k_w & -k_w l_t & 0 & 0 & 0 & k_w & 0 & 0 \\ 0 & 0 & 0 & 0 & -k_w & -k_w l_t & 0 & 0 & k_w & 0 \\ 0 & 0 & 0 & 0 & -k_w & -k_w l_t & 0 & 0 & 0 & k_w \end{bmatrix}$$

And  $C_i$ , The damping matrix of the vehicle, bears the same form as  $[K]$  with  $k_t, k_w$  replaced by  $c_t, c_w$ .